



HAWIDO - REGULATING VALVES

Instruction manual for

**On/Off valve, electrically driven
Type 1603 and 1604**

ND40 - ND100

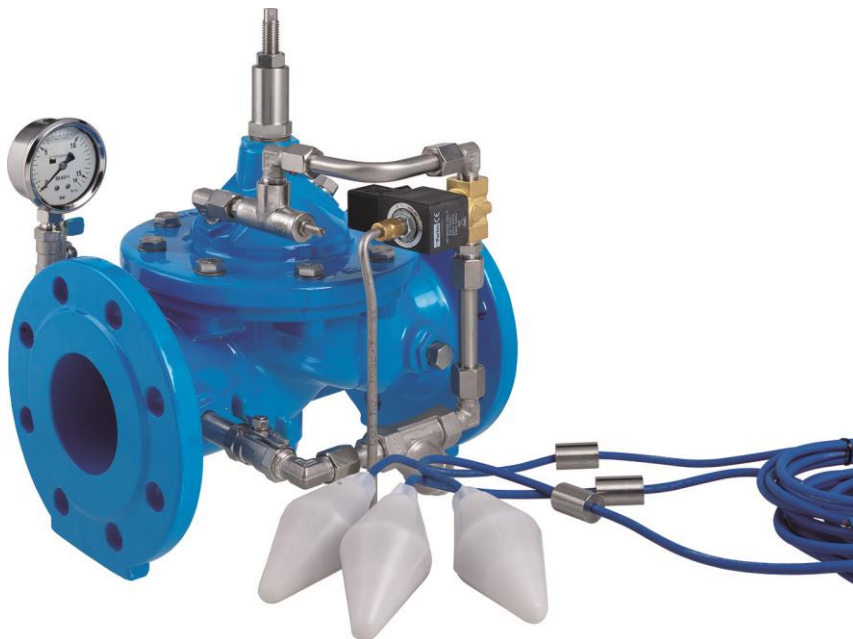

Keep this instruction manual at the location of the valve!

Example of rating plate

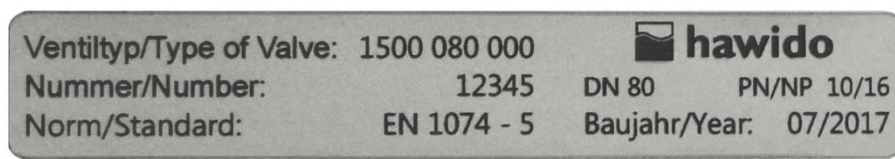

After the commissioning, enter the following data and make use of this additional information regarding the valve type, pressure and flow ratios when consulting the manufacturer or the supplier or asking them questions:

Serial number: DN PN:

Year of manufacture:.....

CONTENTS

A. DESCRIPTION	2
1. FUNCTION	2
2. GENERAL SAFETY INSTRUCTIONS	2
3. RECOMMENDED INSTALLATION	3
B. COMMISSIONING	4
1. FUNCTIONAL DIAGRAM (1603)	4
2. PREPARATORY WORK	4
3. VENTING	5
4. SETTING-UP	5
5. SETTING THE REACTION SPEED	5
6. CHECKING FOR LEAKAGE	5
7. EMERGENCY MANUAL OPERATION	5
C. FAULT FINDING	6
D. PUTTING OUT OF SERVICE AND MAINTENANCE	7
1. PUTTING OUT OF SERVICE	7
2. MAINTENANCE AND SERVICE	7
2.1 GENERAL INFORMATION	7
2.2 ANNUAL FUNCTIONAL CHECKS	7
2.3 4 TO 5-YEAR MAINTENANCE	8
3. REPAIR KITS AND SPARE PARTS	9
3.1 BASE VALVE DN 40 TO DN 100 (DRAWING)	10
3.2 MAIN VALVE (PARTS LIST)	11
3.3 CONTROL LINE INDIVIDUAL PARTS AND ACCESSORIES	12
3.4 FLOAT SWITCH	17
E. ANNEX	18
1. TORQUES	18
F. HAWLE IN EUROPE	19

A. Description

1. Function

Note: Note functional diagram on p. 4.

The on/off valve regulates the water inflow into a reservoir electro/hydraulically using an electrical solenoid valve (5) and floating bulb (6). If the level in the container sinks to a minimum, the main valve opens completely and the container will be filled to the maximum level. The minimum and maximum water levels can be adjusted as desired by the floating bulbs (cable length 5 m). The closing speed can be regulated using the one-way flow restrictor (4).

Valve type 1603: If the electric solenoid valve (5) is energised, the base valve (1) can open (solenoid valve (5) normally closed, HAWIDO normally closed).

Valve type 1604: If the electric solenoid valve (5) is not energised, the base valve (1) cannot open (solenoid valve (5) normally has flow, HAWIDO normally in operation).

The control system (7) is available as an option (art. number 1980 SA0 100).

Technical features:

Medium:	Drinking water
Pressure stages:	PN 10 (from DN 200 Standard) PN16 (up to DN150 Standard)
	Flanges: Connection dimensions according to DIN EN 1092 - 2
Pressure gauge:	EN 837-1; Accuracy class 1.0
Main valve material:	EN-GJS-400-15
Temperature range:	2 – 40 °C

2. General safety instructions

These instructions must be read through carefully and understood before starting the commissioning. Damage to property and injuries to persons could occur as a result of improper installation, commissioning, operation and maintenance.

The regulating valve (HAWIDO) has been designed for use in drinking and process water supplies. Other application media only after consultation with the manufacturer.

The technical regulations (e.g. SVGW, ÖVGW, DVGW...) and codes of practice (e.g. VDE, VDI ...), laws and standards are taken as a minimum standard, and must be adhered to and applied.

Work on electrical installations (e.g. installation of electrical position indicators, solenoid valves, etc.) may only be carried out by personnel authorised for this work. The controller is to be provided by the customer.

In principle, the responsibility for the layout, the installation position, the installation and the commissioning of the fittings in the pipe work lies with the designer, the installation company and/or the operator. Design or installation errors can adversely affect the safe operation of the regulating valve and can represent a significant risk. Please consult us in case of doubt.

3. Recommended installation

Before the installation of the fitting, the pipe lines must be carefully blown or flushed through to prevent any foreign material, such as pieces of wood, stones etc., from entering the regulating valve.

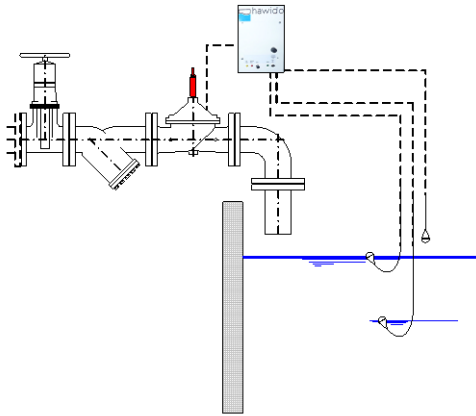

At an inlet pressure of 1.5 to 4, valve types 1603/04 can be used in conjunction with an opening limiter.

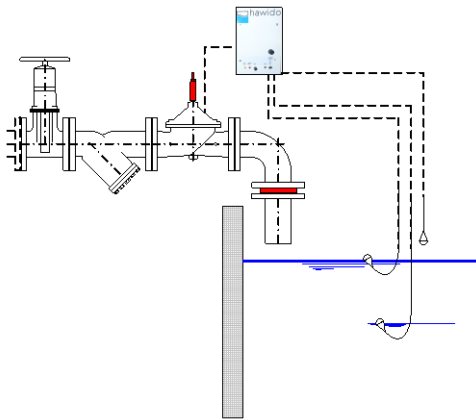

If the inlet pressure lies between 4 and 9, an orifice plate must also be used in addition to the opening limiter. In this way, the pressure is reduced over two stages.

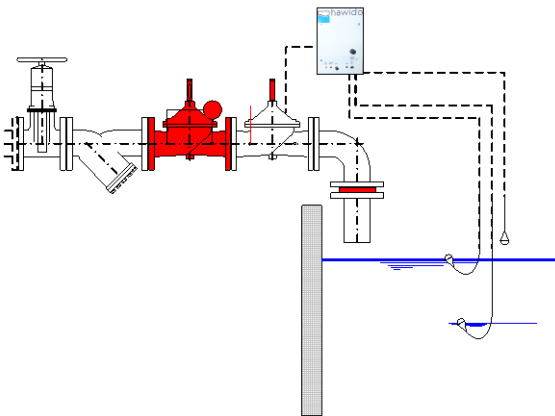

If the inlet pressure lies between 9 and 16 bar, the pressure before the float valve must be reduced with a pressure reducing valve type 1500.

The HAWIDO must be installed horizontally with the valve cover upwards. We recommend that a shut-off valve and a dirt trap be fitted in front of the valve. Before the installation, check that no coarse foreign objects can penetrate into the HAWIDO.

Please contact us for other types of installation.

Electrical control box: not included in the delivery of the valve!

B. Commissioning

1. Functional diagram (1603)

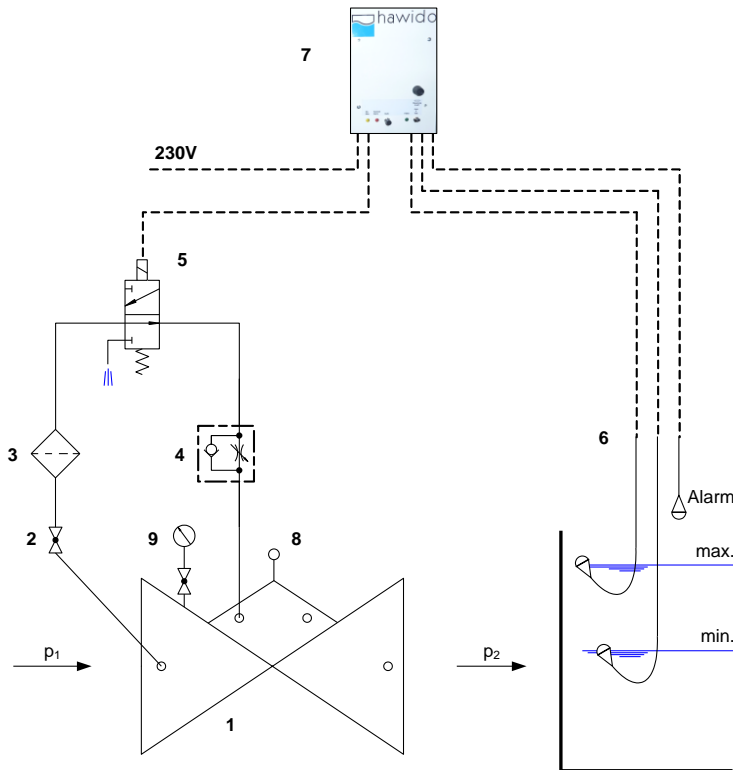

Components

- | | |
|---|--|
| 1 | Main valve 1200 |
| 2 | Ball valve |
| 3 | Filter |
| 4 | One-way flow restrictor |
| 5 | Solenoid valve (drawn for Hawido Valve 1603, for Hawido Valve 1604 solenoid valve no flow without power) |
| 6 | Floating bulbs |
| 7 | Electrical control box not included in the delivery of the valve. Art. No.: 1980 603 A0A) |
| 8 | Optical position indicator (optional) Electrical position indicator (optional) |
| 9 | Valve opening limiter (optional) Pressure gauge with ball valve |

2. Preparatory work

Before commissioning the valve, ensure that the gate valve on the inlet side is **closed** and that the flange connections have been correctly tightened and sealed.

Attention: Electrical work may only be carried out by qualified specialist personnel!

On the valve:

- The ball valve (2A) must be opened and the lock nut of the adjusting screw on the one-way flow restrictor (4) must be loosened
- Unscrew the adjusting screw on the one-way flow restrictor (4) by approximately 10 turns. (The line to the control chamber is open).
- Loosen the threaded pin in the venting elbow by a few turns.

Threaded screw in the venting elbow

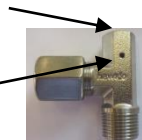

Vent hole

- Loosen the opening limiter on the valve cover by a few turns.
- If the solenoid valve (5) - is to have power removed by the Hawido 1603 or - is to have power applied by the Hawido 1604 the solenoid valves will thereby be open and the line to the control chamber is free.

3. Venting

Procedure:

Slowly open the inlet gate valve on the inlet side until water flows into the valve. The valve fills with water and the air escapes through the vent holes.

When all the air has been expelled by venting the valve in the control line, re-tighten the threaded pin and tighten the opening limiter. Check that all the fittings are properly sealed, and re-tighten if necessary.

Slowly open the inlet gate valve completely.

Check: If the shut-off gate valve on the outlet side is slightly opened, the valve should close or remain closed. Then close the shut-off gate valve again.

If the valve does not close, the commissioning procedure must be repeated from the previous chapter. Particular care must then be taken to ensure that the upper valve chamber and control lines are properly vented.

4. Setting-up

Procedure:

- Pre-setting of the flow control valve (4). Screw in the setting screw as far as it can go and then unscrew it 4 turns.
- Completely open the gate valve on the input side. The valve must remain closed.
- The solenoid valve (5) - on the Hawido 1603 is to have power applied to it (the main valve opens) or - on the Hawido 1604 is to have power removed from it (the main valve opens).

5. Setting the reaction speed

If the HAWIDO does not operate quietly, or if pressure shocks occur in the supply network, this can be corrected by the corresponding adjustment of the one-way flow restrictor (4).

Procedure:

Loosen the locknut. Screw in the set screw clockwise with a screwdriver until the valve operates quietly. Then retighten the locknut.

Caution The set screw must always be open by at least 2 - 3 turns. In the case of large pressure differences, this set screw can also be open less following consultation with the manufacturer.

6. Checking for leakage

The HAWIDO's are tested at the factory for both leakage and function before delivery. When checking for leakage under operational conditions, particular attention must therefore be given to the seals of the flange connections, the control line and the central plug screw on the valve cover. Where necessary, ensure the seal by retightening the connections.

7. Emergency manual operation

If the valve has to be opened manually during a power failure, proceed as described below:

- Slowly close the ball valve (2)
- Slightly loosen the plug (or corresponding accessories such as: opening limiter, valve position indicator etc.) on the valve cover → the valve cover chamber drains itself and the valve opens.
- Put back into operation as described in the *Commissioning* chapter

C. Fault finding

Symptoms	Possible cause	Action
Valve does not open	One-way flow restrictor blocked	Replace or unscrew the set screw several times until the valve functions properly
	One-way flow restrictor closed too far	Screw the set screw in and out until the valve functions properly
	Solenoid valve does not work	Check the function (electrical work may only be carried out by specialist personnel)
Valve does not close	One-way flow restrictor blocked	Replace, or screw the set screw fully in and out several times and then re-set
	Filter in the control line blocked	Clean the filter
	Air in the control line / upper valve chamber	Vent
	Foreign matter in the main valve	Carry out service and remove any foreign matter
	Diaphragm defective	Carry out a service. Replace the diaphragm
	Valve spindle jammed by encrustation	Carry out service and remove any encrustation
	Solenoid valve does not work	Check the function (electrical work may only be carried out by specialist personnel)
Loud noise	Unfavourable operating conditions	Slightly open or close the one-way flow restrictor; Inform Field Service
	Wrong valve size	Have the correct valve size calculated
Erratic operation	One-way flow restrictor incorrectly set	Re-set as described in the <i>Setting the Reaction Speed</i> chapter
EWS coating damaged	Transportation damage, installation damage	Repair with Hawle two-component repair set for coatings

D. Putting out of service and maintenance

1. Putting out of service

The operating valve must first be shut off hydraulically by proceeding as follows:

Attention: Electrical work may only be carried out by qualified specialist personnel!

- **Slowly** close the gate valve in front of the valve

In order to be able to carry out maintenance work on the valve, the solenoid valve must be disconnected from the power. The electrical supply must be disconnected.

The valve has now been taken out of operation, and a service can be carried out.

2. Maintenance and service

2.1 General information

Through our many years of experience with diaphragm valves that are controlled by the flow medium, we know that our HAWIDO's normally function trouble-free for many years. Regular maintenance is a precondition for this, however.

Under normal operating conditions, the following should be carried out:

- The valve should be checked for correct operation once a year (functional check)
- The dirt trap upstream of the valve and the filter in the control line should be cleaned once a year
- The inner working components should be checked and worn parts be replaced every four to five years (maintenance).

Under unusual operating conditions (e.g. with water that contains quantities of suspended matter, very high pressure reduction, small flow rates etc.), the functional checks and the service work should be carried out more frequently.

Maintenance sign:

Funktionskontrolle: jährlich	Wartung:	20xx
Contrôle fonctionnel: annuel	Maintenance:	
Prova di funzionamento: ogni anno	Mantenzione:	
Function check: annually	Maintenance:	

xx stands for the respective year.

2.2 Annual functional checks

Cleaning the dirt trap in the main line

- Unscrew the lid
- Clean filter (use soft brushes, cloths or similar), or possibly replace filter
- Install the filter and screw the lid back on

Cleaning the filter in the control line

- Unscrew the lid of the filter

- Clean filter (use soft brushes, cloths or similar), or possibly replace filter
- Re-install the filter and screw the filter lid back on

Checking the valve

- Remove opening limiter or assembled accessories.
- Check the easy movement of the valve spindle by lifting and lowering with the spindle tool (article number 1199, see chapter "Control line individual parts and accessories").
- Assemble opening limiter or assembled accessories.

Putting back into service

- as described in the *Commissioning* paragraph

Functional check of the valve

- **Valve 1603:**
Solenoid valve (5) inactive (→ solenoid valve has flow) HAWIDO closes
Solenoid valve (5) has power (→ Solenoid valve closed) HAWIDO opens
- **Valve 1604:**
Solenoid valve (5) has power (→ solenoid valve has flow) HAWIDO closes
Solenoid valve (5) inactive (→ Solenoid valve closed) HAWIDO opens

2.3 4 to 5-year maintenance

Cleaning the dirt trap in the main line

- Unscrew the lid
- Clean filter (use soft brushes, cloths or similar), or possibly replace filter
- Install the filter and screw the lid back on

Cleaning the filter in the control line

- Unscrew the lid of the filter
- Clean filter (use soft brushes, cloths or similar), or possibly replace filter
- Re-install the filter and screw the filter lid back on

Main valve (see Chapter 3)

- Undo the fittings of the control line and put the complete control line to one side.
- Undo the screws of the valve cover and remove the cover.
- Visually inspect all inner components for wear, dirt and scaling
- Clean the inner components, the seat and the inner surfaces, including the cover
- Dismantle the spindle guide in the housing, flush the body interior
For valves DN 40 to DN 100 the spindle guide is dismantled from the inside. Here the thread of the spindle guide and the base valve must be **extremely clean**. Grease the thread thoroughly (e.g. Foodgrease Aqua, Art. no. 5292, see chapter "Control line individual parts and accessories").
- Replace the diaphragm, the O-ring and, if necessary, the seat seal
- Lightly grease the area around the spindle guide with a grease suitable for contact with food. Check the easy movement of the spindle in the housing guide and in the cover guide.
- Re-assemble the main valve. During the assembly, the easy movement of the spindle must be checked **several times** by actuating the threaded rod

Functional check of the one-way flow restrictor

- Undo the locknut
- Screw in the throttle screw, and then unscrew it as far as it goes
- Screw in again a few turns. This process must be easy and meet little resistance

Putting back into operation and functional check

- In accordance with the Commissioning and Functional Check chapter and the previous chapter

3. Repair kits and spare parts

Several replacement parts are required for the 4 or 5 - year service. These can be obtained as a repair kit for:

- the main valve
- the control valve
- the control line
- the optical position indicator

The article numbers can be found in the part lists and the lists of spare parts.

Attention:

When ordering replacement parts, always specify the valve type, serial number and year of construction!

Important:

Replacement parts made of EPDM (diaphragms, seals) and NBR (O-rings) must be stored in a dark place, protected from UV radiation!

Shelf-life when stored in the dark:

EPDM 8 years from date of manufacture

NBR 5 years from date of manufacture

3.1 Base valve DN 40 to DN 100 (drawing)

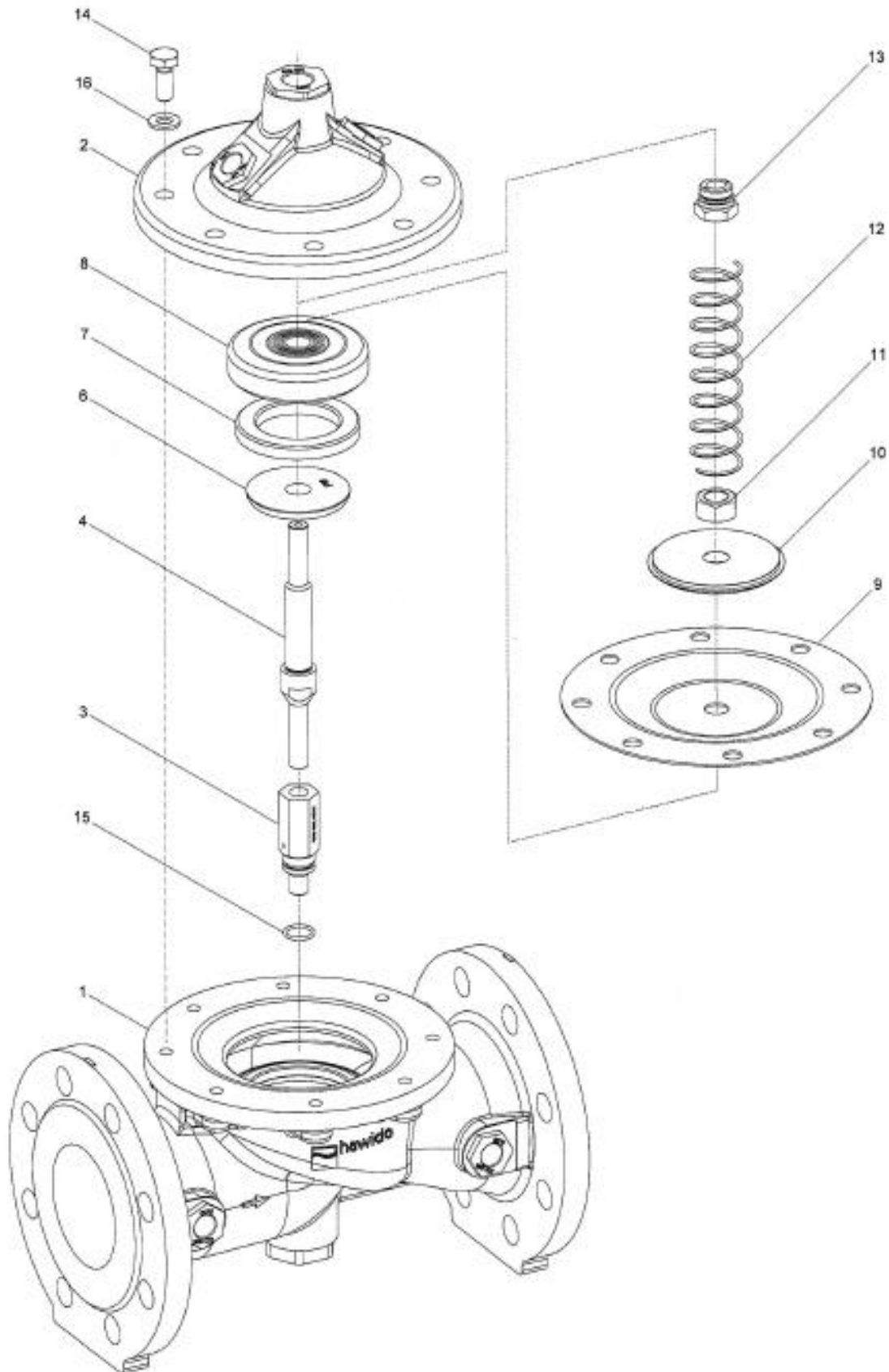

08.12.2011/plü

3.2 Main valve (Parts list)

Item.	Description	Material	Article number				
			DN 40	DN 50	DN 65	DN 80	DN 100
1	Body	GGG 40	1004 040 000	1004 050 000	1004 065 000	1004 080 000	1004 100 000
2	Valve cover	GGG 40	1014 050 000	1014 050 000	1014 065 000	1014 080 000	1014 100 000
3	Spindle guide cover	INOX	1024 900 000	1024 900 001	1024 900 002	1024 900 003	1024 900 004
4	Spindle	INOX	1026 050 000	1026 050 000	1026 065 000	1026 080 000	1026 100 000
5	Seat	INOX	*	*	*	*	*
6	Counter seat	INOX	1044 040 001	1044 050 001	1044 065 001	1044 080 001	1044 100 001
7	Seal	EPDM	1022 040 000	1022 050 000	1022 065 000	1022 080 000	1022 100 000
8	Seal carrier	INOX	1027 040 200	1027 050 200	1027 065 200	1027 080 200	1027 100 200
9	Diaphragm PN10/16	EPDM	1020 050 000	1020 050 000	1020 065 000	1020 080 000	1020 100 000
	Diaphragm PN25	EPDM	1020 050 000	1020 050 000	1021 065 000	1021 080 000	1021 100 000
10	Pressure disc	INOX	1047 050 000	1047 050 000	1047 065 000	1047 080 000	1047 100 000
11	Nut	INOX	0007 710 080	0007 710 080	0007 712 080	0007 716 080	0007 716 080
12	Spring	INOX	1049 050 000	1049 050 000	1049 065 000	1049 080 000	1049 100 000
	Spring for valves installed upright position	INOX	1050 050 000	1050 050 000	1050 065 000	1050 080 000	1050 100 000
13	Spindle guide cover	INOX	1042 900 000	1042 900 000	1042 900 001	1042 900 002	1042 900 002
14	Hexagonal screw	INOX	0006 608 020	0006 608 020	0006 610 025	0006 610 025	0006 612 025
15	O-ring	NBR	0180 012 020	0180 012 020	0180 012 020	0180 016 020	0180 016 020
16	Washer	INOX	0008 208 000	0008 208 000	0008 210 000	0008 210 000	0008 212 000
17	GSK-sticker		1099 900 000	1099 900 000	1099 900 000	1099 900 000	1099 900 000
18	Maintenance sticker		9691 0xx 000	9691 0xx 000	9691 0xx 000	9691 0xx 000	9691 0xx 000
	Main valve complete	PN10/16	1201 040 000	1201 050 000	1201 065 000	1201 080 000	1201 100 000
	Main valve complete	PN25	--	--	1201 065 025	1201 080 025	1201 100 025
	Repair kit for main valve with stainless steel connection, comprising item 7, 9, 15, 18	PN10/16	1080 040 000	1080 050 000	1080 065 000	1080 080 000	1080 100 000
		PN25	1080 040 000	1080 050 000	1081 065 000	1081 080 000	1081 100 000

° PN10
 ^ PN16
 * not interchangeable
 16.03.2018/plü



3.3 Control line individual parts and accessories





Master number Designation	Picture	Size further sizes possibly available	Art. number
0130 Compound seal		Stainless steel/NBR 3/8" Stainless steel/NBR 1/2" Stainless steel/NBR 3/4" Steel/NBR 1"	0130 012 000 0130 016 000 0130 025 000 0130 032 000
0273 Individual parts		Fitting connection (consisting of: connector nut and clamping ring) DN 12 stainless steel	0273 012 000
0275 Support sleeve		Stainless steel d4 – 6 Stainless steel d12 – 9 Stainless steel d12 – 10	0275 006 004 0275 012 009 0275 012 010
0283 Clamping ring		d6 Stainless steel d12 Stainless steel d18 Stainless steel d8 - 6 Stainless steel	0283 006 000 0283 012 000 0283 018 000 0283 008 006
0284 Orifice plate (Old orifice plate number 0281.		d12 Stainless steel Ø 0.6 mm d12 Stainless steel Ø 0.9 mm d12 Stainless steel Ø 1.2 mm d12 Stainless steel Ø 1.5 mm d12 Stainless steel Ø 1.9 mm d12 Stainless steel Ø 2.4 mm d12 Stainless steel Ø 3.1 mm d18 Stainless steel Ø 3.5 mm d18 Stainless steel Ø 4.0 mm	0284 006 000 0284 009 000 0284 012 000 0284 015 000 0284 019 000 0284 024 000 0284 031 000 0284 035 010 0284 040 010
0311 fitting with screw-in nipple		d 12 - 3/8" Stainless steel d 12 - 1/2" Stainless steel d 6 - 1/8" Stainless steel d 6 - 1/4" Stainless steel d 6 - 3/8" Stainless steel d18 – 1/2" Stainless steel	0311 012 012 0311 012 016 0311 006 004 0311 006 008 0311 006 012 0311 018 016
0323 Straight fitting		d 6 Stainless steel d 12 Stainless steel	0323 006 000 0323 012 000
0324 Straight socket end fitting		d12 - 3/8"	0324 012 012
0351 Reduction fitting		d6 – d12 stainless steel	0351 012 006
0361 Transition sleeve		d 10 - 3/8" Stainless steel d 12 - 3/8" Stainless steel d 12 - 1/2" Stainless steel d 18 – 1/2" Stainless steel	0361 010 012 0361 012 012 0361 012 016 0361 018 016
0371 Reduction nipple		IG d 12 – AG 3/8" Stainless steel	0371 012 012

0401 Sleeve		3/8" Stainless steel 1/2" Stainless steel 3/4" Stainless steel 1" Stainless steel	0401 012 000 0401 016 000 0401 025 000 0401 032 000
0411 Adjuster nipple		DN 6 - 1/8" Stainless steel DN12 - 3/8" Stainless steel	0411 006 004 0411 012 012
0431 Screw-in elbow		DN 6 - 1/8" Stainless steel DN6 - 1/4" Stainless steel DN12 - 3/8" Stainless steel DN18 - 1/2" Stainless steel	0431 006 004 0431 006 008 0431 012 012 0431 018 016
0431 Screw-in elbow with vent		DN 123/8" Stainless steel	0431 012 013
0451 Angled fitting		DN6 Stainless steel DN12 Stainless steel DN18 Stainless steel	0451 006 000 0451 012 000 0451 018 000
0452 90° Adjuster elbow		DN12	0452 012 000
0455 Connector elbow		IG 3/8" Stainless steel IG 1/2" Stainless steel IG 3/4" Stainless steel IG 1" Stainless steel	0455 012 000 0455 016 000 0455 025 000 0455 032 000
0456 Connector elbow		IG 3/8" - AG 3/8" Stainless steel IG 1/2" - AG 1/2" Stainless steel IG 3/4" - AG 3/4" Stainless steel IG 1" - AG 1" Stainless steel	0456 012 000 0456 016 000 0456 025 000 0456 032 000
0461 T-piece		d6 Stainless steel d12 Stainless steel d12 - 6 - 12 Stainless steel d18 stainless steel	0461 006 000 0461 012 000 0461 012 006 0461 018 000
0510 Plug		AG 3/8" conical stainless steel AG 1/2" conical stainless steel	0510 012 000 0510 016 000
0511 Vent plug, Lock screw		AG 1/2" Stainless steel AG 3/4" Stainless steel AG 1" stainless steel with hexagon socket	0511 016 000 0511 025 000 0511 032 001
0520 hexagon double nipple		d 1/8" Stainless steel d 1/4" Stainless steel d 3/8" Stainless steel d 1/2" Stainless steel d 3/4" Stainless steel	0520 004 000 0520 008 000 0520 012 000 0520 016 000 0520 025 000
0541 Ball valve		DN 3/8" stainless steel DN 1/2" stainless steel DN 3/4" stainless steel	0541 012 001 0541 016 000 0541 016 010

<p>0545 Stainless steel dirt filter</p>		<p>Stainless steel Y-filter IG 3/8" Individual parts: Stainless steel dirt filter Plug, complete for Y-filter, stainless steel Large seal for Y-filter, POM Small O-ring for plug</p>	<p>0545 112 002 0545 900 051 0545 112 010 0545 112 011 0545 112 012 0545 116 000</p>
<p>0549 Flow control valve & check valve</p>		<p>DN 3/8" Check valve brass nickel-plated Stainless steel IG 3/8" type B d 12 with long spindle</p>	<p>0549 000 002 0549 000 005</p>
<p>0570 Non-return valve</p>		<p>3/8" brass (max. 40 bar) 1/2" brass (max. 40 bar)</p>	<p>0570 012 045 0570 016 045</p>
<p>0600 Pressure gauge</p>		<p>AG 3/8" 0 - 6 bar AG 3/8" 0 - 10 bar AG 3/8" 0 - 16 bar AG 3/8" 0 - 25 bar AG 3/8" 0 - 40 bar AG 3/8" 0 - 60 bar</p>	<p>0600 012 006 0600 012 010 0600 012 016 0600 012 025 0600 012 040 0600 012 060</p>
<p>0610 Solenoid valves</p>		<p>Solenoid valve, normally open 2/2-way valve (for 1795/96) 122K84</p> <p>Solenoid valve, normally closed 2/2 way valve (for 1795/96) E121K04</p> <p>Solenoid valve, normally open 3/2 way valve (for 1703 to DN 100 1603, 1706 PN 16 all nominal sizes) 132K04</p> <p>Solenoid valve normally closed 3/2 way valve (for 1704 to DN 100, 1604) E131K04</p> <p>Solenoid valve normally open 2/2 way valve (for 1704 from DN 125 1304, 1404, 1504) (old: E322 H73 06)</p> <p>Solenoid valve normally closed 2/2 way valve, with manual override (For 1703 from DN 125,1303, 1403, 1503, 1706 PN 25 from DN 125) (old: E321 (H13)</p> <p>Solenoid valve universal 3/2 way valve (for 1706 PN 25 to DN 100)</p> <p>*****</p> <p>Replacement part. Diaphragm, for MV type 0610 510 001 and 0610 510 002</p> <p>Replacement part set for MV type 0610 510 001 Consisting of: Diaphragm, Armature guide tube, armature and seals</p>	<p>0610 122 084</p> <p>0610 121 004</p> <p>0610 132 004</p> <p>0610 131 004</p> <p>0610 510 002</p> <p>0610 510 001</p> <p>0610 133 005</p> <p>*****</p> <p>0610 590 001</p> <p>0610 590 002</p>

<p>0620, 0621 Coils</p>		<p>AC coils with voltage indication</p> <p>DC coils with voltage indication</p>	<p>0620 xxx xxx</p> <p>0621 xxx xxx</p>
<p>0630 Appliance socket</p>		<p>Appliance socket for electromagnet</p>	<p>0630 000 000</p>
<p>0653 Connector modules</p>		<p>Connector modules for solenoid valves Type LBV 24 DC 8S, incl. 2m cable</p> <p>Connector modules for solenoid valves Type LBV IN: 48-230VAC/DC OUT: 48VDC incl. 2m cable 3-wire (Only to be used for 48VDC coils)</p>	<p>0653 024 008</p> <p>0653 230 000</p>
<p>0670 Overcut</p>		<p>AG 3/8" IG 1/8" Stainless steel AG 3/8" IG 1/4" Stainless steel AG 1/2" IG 3/8" Stainless steel AG 3/4" IG 3/8" Stainless steel AG 1" IG 1/8" Stainless steel AG 1" IG 1/2" Stainless steel</p>	<p>0670 012 004 0670 012 008 0670 016 012 0670 025 012 0670 032 012 0670 032 016</p>
<p>0671 Sleeve nipple reduced</p>		<p>IG 1/2" AG 3/8" IG 1" AG 3/8" IG 1" AG 1/2" IG 1" AG 3/4"</p>	<p>0671 016 012 0671 032 012 0671 032 016 0671 032 025</p>
<p>0680 Barrel nipple</p>		<p>AG 3/8" L = 30 mm Stainless steel AG 3/8" L = 40 mm Stainless steel AG 3/8" L = 50 mm Stainless steel AG 3/8" L = 60 mm Stainless steel AG 3/8" L = 70 mm Stainless steel AG 3/8" L = 80 mm Stainless steel AG 3/8" L = 110 mm Stainless steel AG 1/2" L = xxx mm Stainless steel</p>	<p>0680 012 030 0680 012 040 0680 012 050 0680 012 060 0680 012 070 0680 012 080 0680 012 110 0680 016 xxx</p>
<p>0690 Adapting nipple</p>		<p>AG 3/8" - 1/8" AG 3/8" - 1/4" AG 1/2" - 3/8" AG 3/4" - 3/8" AG 1" - 3/8" AG 1" - 1/2"</p>	<p>0690 012 004 0690 012 008 0690 016 012 0690 025 012 0690 032 012 0690 032 016</p>
<p>0711 T-fitting</p>		<p>IG 3/8" level Stainless steel IG 1/2" level Stainless steel IG 3/4" level Stainless steel IG 1" level Stainless steel</p>	<p>0711 012 000 0711 016 000 0711 025 000 0711 032 000</p>
<p>0730 Seamless tube</p>		<p>d6 x 1mm Stainless steel d12 x 1.5 mm Stainless steel d15 x 1.5 mm Stainless steel d18 x 1.5 mm Stainless steel</p>	<p>0730 006 010 0730 012 015 0730 015 015 0730 018 015</p>

<p>1188 Rep. Set Control line</p>		<p>From serial number 14252 (January 2003) DN40 to 100 DN125 to 300</p> <p>From approx. serial number 25915 (June 2014, Filter type B (0545 112 002) DN40 to 100 DN125 to 200</p>	<p>1188 065 100 1188 125 300</p> <p>1188 000 000 1188 000 001</p>
<p>SA.0 PA-tube</p>		<p>Polyamide tube OD 6 mm, ID 4 mm Polyamide tube OD 12 mm, ID 9 mm</p>	<p>SA.0 000 060 SA.0 000 290</p>

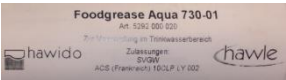
<p>Tools and accessories</p>			
<p>1199 Spindle lifting tool</p>		<p>M5 M6</p>	<p>1199 000 000 1199 000 010</p>
<p>1199 Spanner for sealing plate</p>		<p>Spanner for assembling and dismantling the sealing plate from the DRV pilot valve</p>	<p>1199 000 020</p>
<p>1199 Socket spanner attachment</p>		<p>Socket spanner attachment for flow control valve</p>	<p>1199 000 030</p>
<p>1199 Socket spanner</p>		<p>Socket spanner for flow control valve</p>	<p>1199 000 040</p>
<p>5292 Grease</p>		<p>Foodgrease Aqua Tube with 175g</p>	<p>5292 000 020</p>

02.02.2018/plü

3.4 Float switch

Circuit diagram:

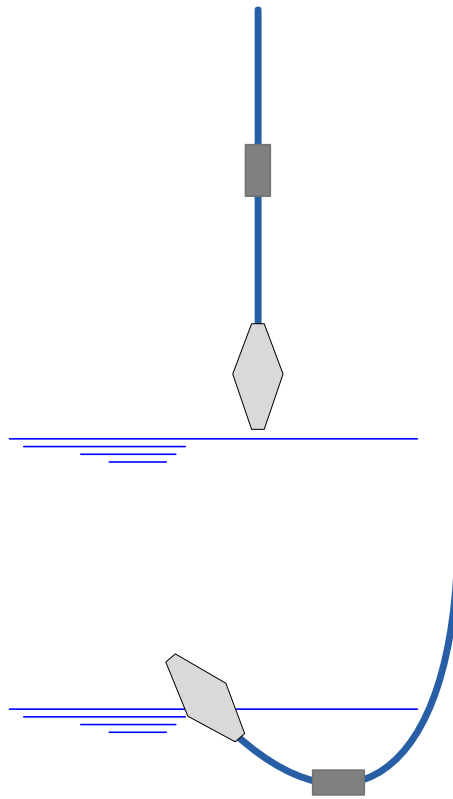
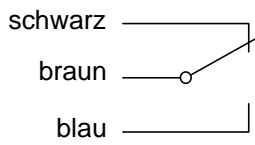
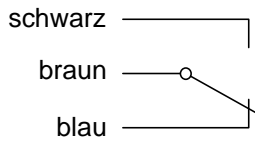

Technical information:

max. voltage range	250 VAC
max. current range	16 A
max. pressure range	3.5 bar
Temperature range:	up to max. 85 °C
Cable length:	5 m, made of EPDM
Protection class:	IP 68
Art. no.:	0660 900 006

Optionally available:



Cable holder 0660 900 007

14.12.2011/plü

E. Annex

1. Torques

When assembling the base valve and the control valves all **bolts** are checked with a torque spanner according to the following list. Lightly grease the bolts before assembling!

Base valves	Nominal size DN	Hex bolt M	Strength class ¹⁾	Tightening torque	
				Target	Max. ²⁾
	40 - 50	M 8	A4/80	22 Nm	25 Nm
	65 - 80	M 10		47 Nm	50 Nm
	100	M 12		84 Nm	87 Nm
	125 - 150	M 16		172 Nm	216 Nm
	200	M 20		285 Nm	423 Nm
	250	M 20		285 Nm	423 Nm
300	M 20	380 Nm		423 Nm	

Control valves	Type	Socket M	Strength class ¹⁾	Tightening torque	
				Target	Max.
	DRV / DAV	M 6	A2 / A4 / 70	8 Nm	8.5 Nm
	MBV / RBS				
Control valve	Hex bolt M	Strength class	Tightening torque		
NAZ	M 6	A2 / A4 / 70	8 Nm	8.5 Nm	

(Not for new applications)

Base valves	Nominal size DN	Hex bolt M	Strength class ¹⁾	Tightening torque	
				Target	Max.
	40 - 50	M 8	A2/70	17 Nm	19 Nm
	65	M 10		33 Nm	36 Nm
	80	M 10		40 Nm	40 Nm
	100	M 12		70 Nm	72 Nm
	125 - 150	M 16		172 Nm	172 Nm
	200	M 20		280 Nm	285 Nm
	250	M 20		280 Nm	285 Nm
300	M 20	235 Nm		240 Nm	

Attention: ¹⁾ = Note designation on screw head A2 – 70 or A4 – 80!

²⁾ = Maximum permitted torque according to strength analysis

Bolts according to SN EN ISO 4014 and SN EN ISO 4017

As at: FO 0065, Rev. 12 / 19.12.2017

F. Hawle in Europe

Addresses:

Hawle Armaturen AG
Hawlestrasse 1
CH-8370 Sirnach
www.hawle.ch

telephone +41 (0)71 969 44 22
fax +41 (0)71 969 44 11

Hawle Armaturen GmbH
Liegnitzer Strasse 6
D-83395 Freilassing
www.hawle.de

telephone +49 (0)8654 63 03 - 0
fax +49 (0)8654 63 03 60

E. Hawle Armaturenwerke GmbH
Wagrainerstr. 13
A-4840 Vöcklabruck
www.hawle.at

telephone +43 (0)76 72/72 576 0
fax +43 (0)76 72 78 464

Hawle Kft
Dobogókői út 5
H-2000 Szentendre
www.hawle.hu

telephone +36 (0) 26 501 501
fax +36 (0) 26 501 502

Hawle Armatury spol. s r.o.
Ricanská 375
CZ-25242 Jesenice u.Prahy
www.hawle.cz

telephone +420 (0)2 410 03 111
fax +420 (0)2 41 00 33 33

Hawle Spółka zo.o
ul. Piaskowa 9
PL-62-028 Kozięglowy
www.hawle.pl

telephone +48 (0)61 811 14 00
fax +48 (0)61 811 14 27

Hawle s.r.o.
Pezinská c.30
SK-903 01 Senec
www.hawle.sk

telephone +421 (0)2 45 92 21 87
fax +421 (0)2 45 92 21 88

S.C. Hawle S.R.L.
Calea Sagalui 104
RO-300516 Timisoara
www.hawle.ro

telephone +40 268 47 78 81
fax +40 356 80 06 68

DM Armaturen EOOD
Ul. Lokomotiv 3
BG-1220 Sofia
www.hawle.bg

telephone +359 (0)2 931 12 77
Fax +359 2 931 04 36

Partners / Contact addresses:

28.07.2014-1/plü