

Regulating valves, dirt traps

Hawido-regulating valves – reliable, functional and durable



Functional

- The control line can be shut off, enabling a functional check without any interruptions.
- Pressure gauges and an optical position indicator provide a simple and rapid status display
- The integrated venting system ensures quick and simple commissioning
- Simple and safe valve setting with a unique lever system – no special tools required

Extremely durable

- Excellent corrosion resistance due to the 250 µm coating and stainless steel control line connections
- Highest precision on all components results in the lowest wear
- Maximum protection against corrosion as all the components are made from stainless steel.
- Control system is protected by an integrated dirt filter
- Customers can be assured of a choice based on their specific needs and benefit from regular support thanks to the expert advice they receive and our in-house service organisation.

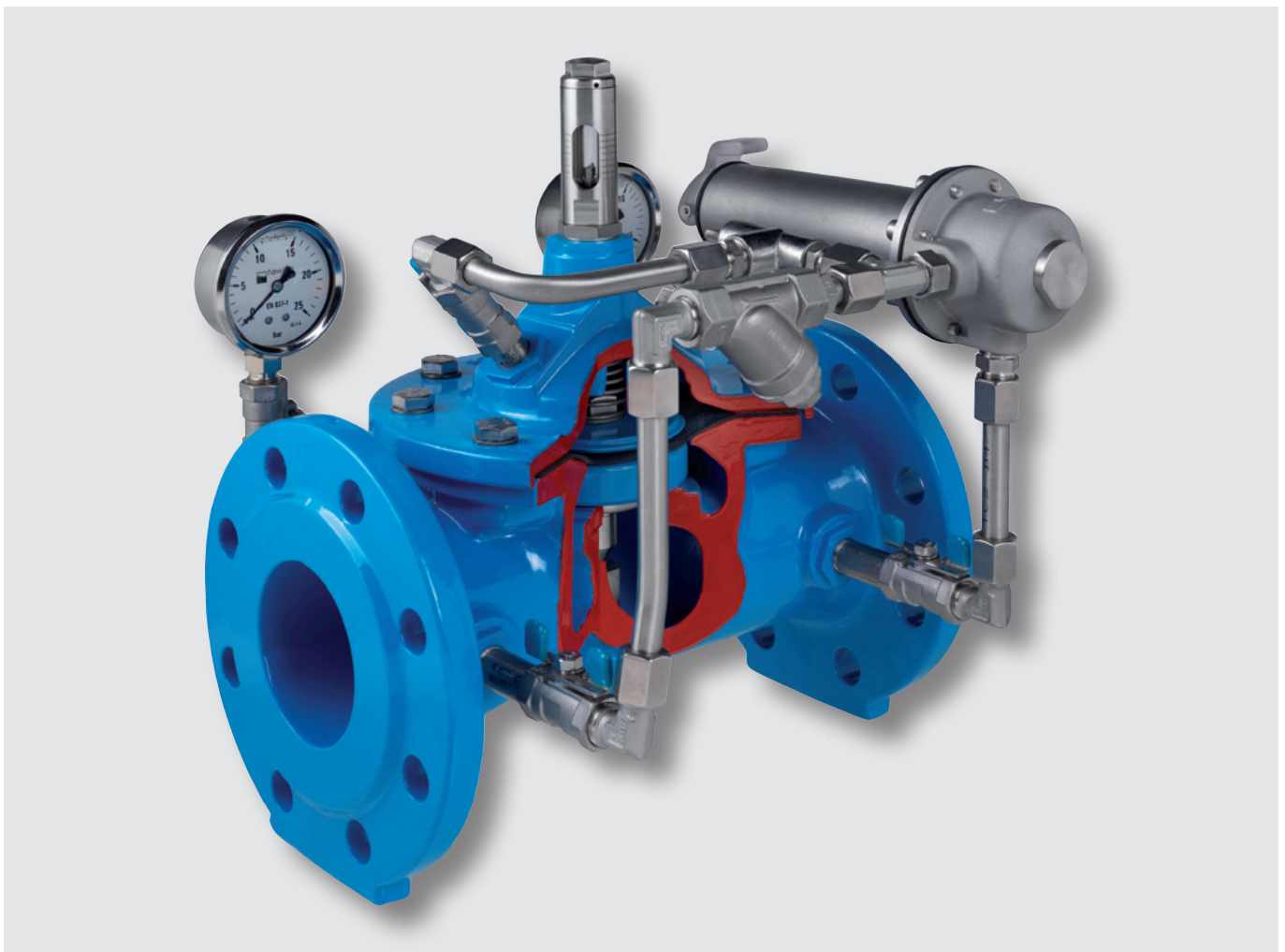
**Reliable and safe**

- Maximum protection of your water pipeline system thanks to simple, proven and reliable technology
- 100% output inspection of all valves
- Expert advice and support when selecting the products and at commissioning.
- The unique valve seat geometry ensures highest precision.
- SVGW-certification and many international approvals and certificates, mainly in the drinking water supply sector (max. 40°C)

Cost-effective

- High-quality materials increase the service life
- The control and regulation systems do not require any external energy
- Easy to maintain and service thanks to the clever design
- Maximum protection against corrosion extends the service life.
- The wide range of products allows for very individual solutions tailored to specific situations.
- Maintenance-optimised design

Hawido regulating valves – the right choice for every situation

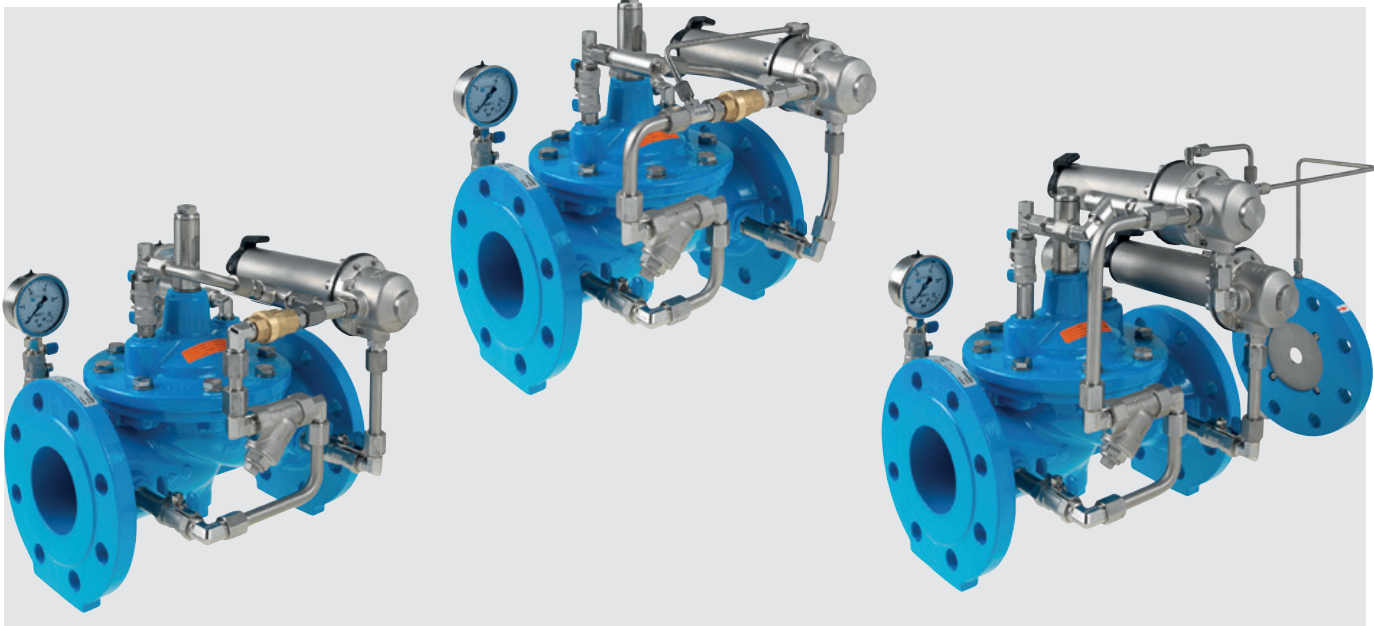

Pressure reducing valves (outlet pressure control) Series 1500

The pressure reducing valve reduces a variable inlet pressure to an accurate and constant outlet pressure. Fluctuating inlet pressure and flow do not affect the regulated outlet pressure - this can be set as standard in the range 1.5 to 12 bar.

Application In the drinking water sector, to supply the network and in emergency feeds.

Variants With backflow prevention, electrically controlled, for two pressure levels, motor-controlled and combinations

Pressure relief- and pressure retention valve (inlet pressure control) Series 1400

The valve keeps an inlet pressure (p_1) set at the control valve, constant, irrespective of a fluctuating flow. If the inlet pressure (p_1) exceeds the pre-set pressure, the valve quickly opens. The closing process is slow thereby preventing any surges in pressure – the pressure can be set as standard in the range 2 to 16 bar.

Application Maintaining the network pressure and protecting against excess pressure

Variants With backflow prevention, electrically controlled, with float control and combinations

Flow and volume control valves (volume control) Series 1300

With this valve, a defined flow rate can be limited purely – irrespective of any changes in operating pressure. With the control valve, the flow rate can be adjusted progressively +/- 15%.

Application In front of a filter, to secure the extinguishing water reserve in the primary network and to limit the inflow into a lower pressure zone

Variants With backflow prevention, electrically controlled or with float control, with pressure reduction

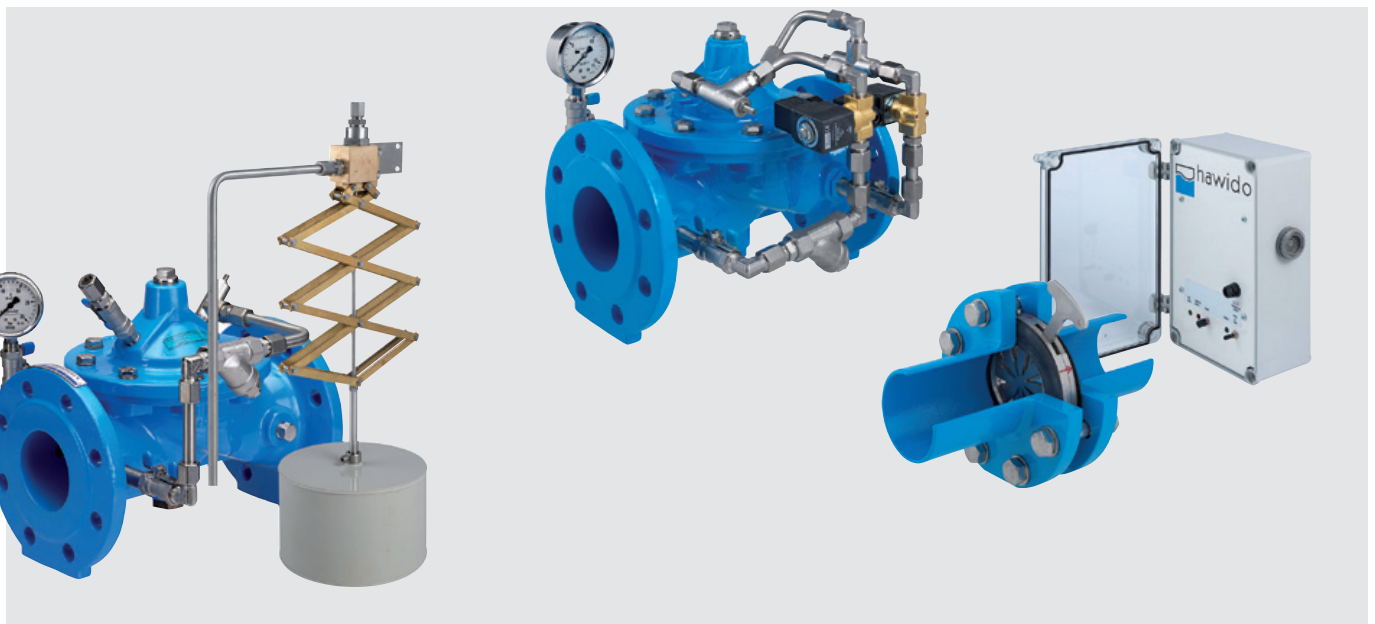

**On/off valves
(water level control)
Series 1600**

This valve controls the inflow into a basin with the help of the float and control valve. It is hydraulically/mechanically controlled. The closing speed can be regulated by a way flow control valve. This prevents surges in pressure.

Application Regulation of levels in reservoirs, pressure breaker shafts, equalising basins, etc.

Variants Electrically controlled, with float control and combinations

**On/Off valve for electrical actuation
(special functions)
Series 1700**

This type of valve can be controlled via the solenoid valves installed in the control line by means of an electrical signal. As a result, it can also be controlled step by step. The valve opens and closes purely hydraulically. The closing speed can be adjusted by means of a flow control valve to prevent surges in pressure.

Application Open and close using an electrical signal

Special valves and accessories

Special valves Our experienced application engineers will provide you with expert and comprehensive advice. We look for the optimum solution for you base on our wide range: by combining existing valves or developing a valve specific to your needs.

Accessories Our range is supplemented with various products: for example, adjustable orifice plates, electrical position indicators or the control unit for the on/off valve no. 1603 and much more

Hawido regulating valves – The correct installation ensures a safe operation

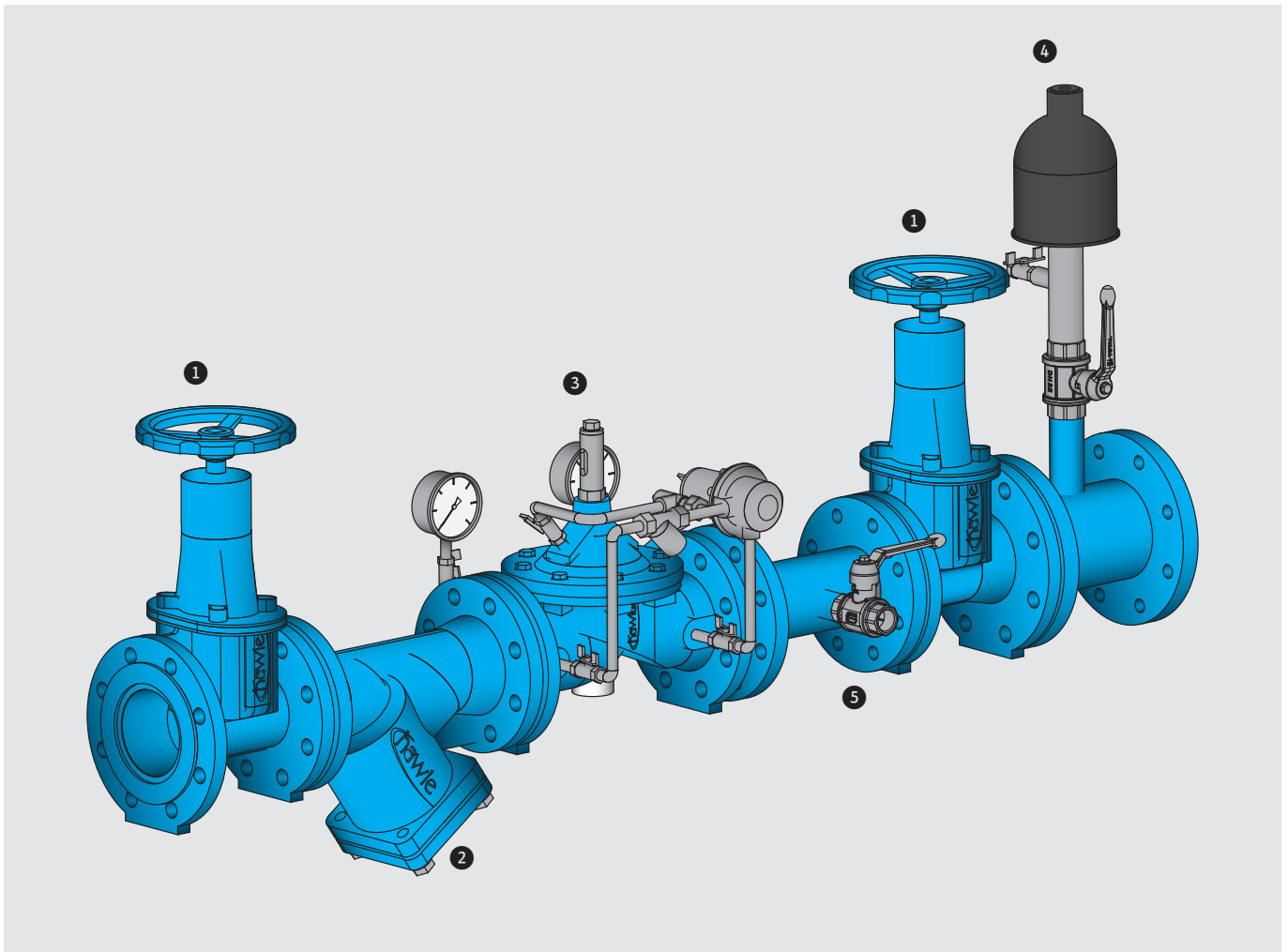

Functional

Hawido recommends the installation example shown. This ensures optimum performance and maximum safety. In addition, this makes it quick and easy to service.

- 1 Slider** This shut-off function is necessary for regular maintenance work.
- 2 Dirt traps** prevent particles from entering the valve, thereby protecting the valve seat and ensuring the operability of the valve.
- 3 Valve**
- 4 Ventilator** It is advisable to install an aeration/ventilation valve, as it protects the pipeline network against a vacuum forming during inspections (shut-off valve closed) and simultaneous drawing of water. In addition, air can also be separated after the pressure has been reduced.
- 5 Drain cock** The drain cock is used to relieve pressure on the outlet side. The outlet pressure can be set correctly when the outlet slider is closed. Water samples can be taken.

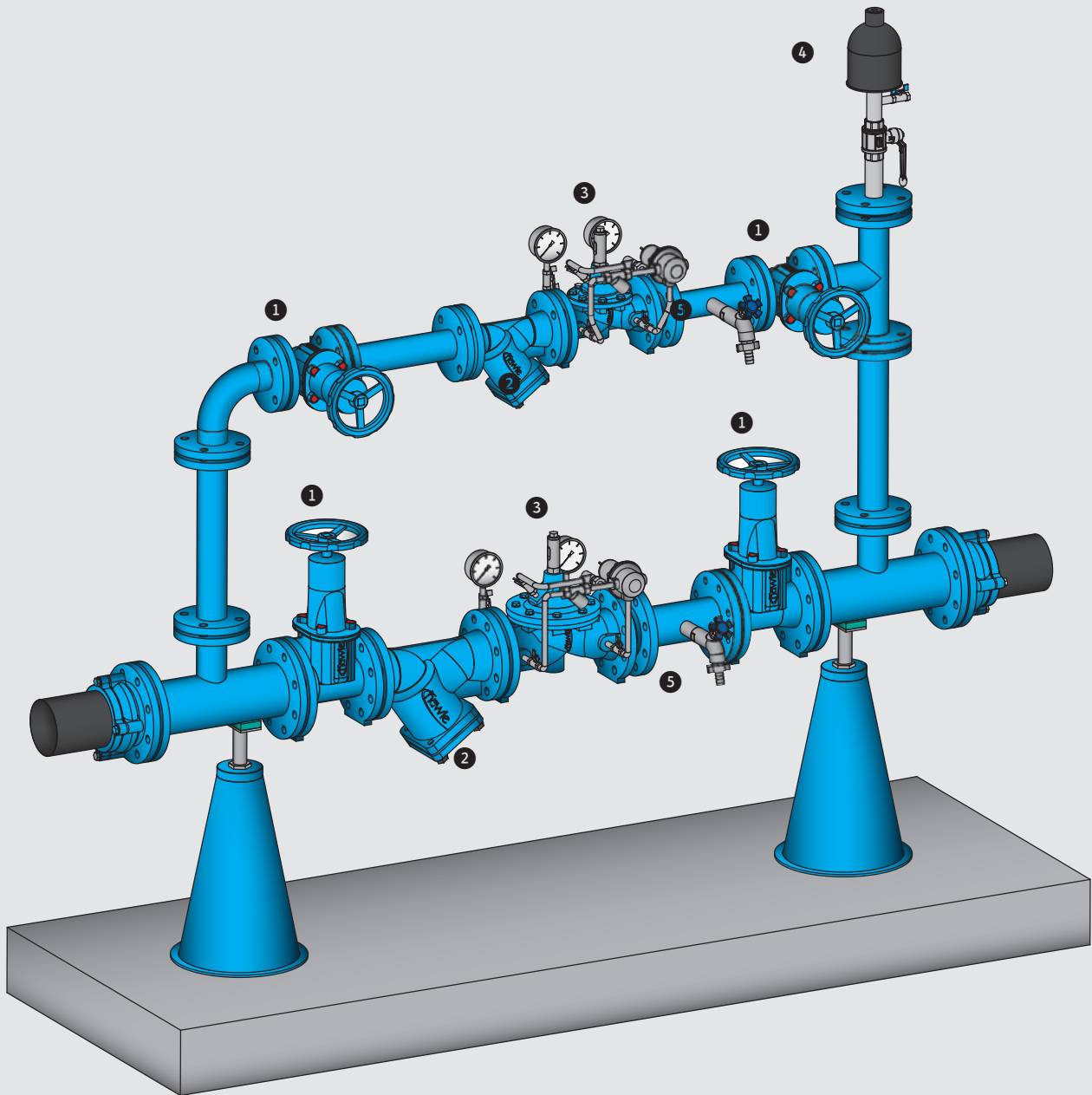

By-pass for uninterrupted maintenance and inspection, installation recommendation

The installation of a by-pass is recommended for an uninterrupted servicing of the valves. This installation is also planned for extremely large differences with minimum and maximum usage volumes.

Application example The main valve DN 100 is bypassed with a smaller pipe DN 50. A dirt trap and valve (DN 50) must also be installed here.

Regulating valves – Hawle-Service



The service technicians at Hawle guarantee a regular supply

In order to ensure the safety of your network, we recommend a Hawle Service Agreement. To access our expertise in your local area:

1. Our service technician contacts you to arrange the annual maintenance.
2. Whilst he carries out the functional checks or inspection, you can dedicate your time to getting other important jobs done.
3. The service fee is the same every year – only materials are charged.
4. We guarantee a reliable supply and will arrive on site as quickly as possible in the event of a fault. If one of our valves causes an interruption to your supply, you are not charged for the labour or travel expenses.

To ensure your network is safe and free from faults, we recommend a Hawle Service Agreement.

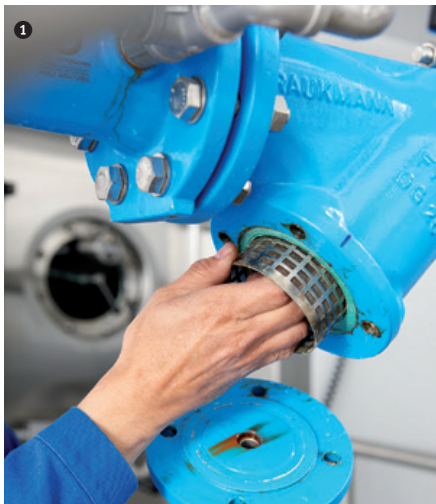

The Hawle Service Agreement includes comprehensive services

- 1 The dirt trap is opened and cleaned once a year.
- 2 Every five years, the base valve is opened and closed, the membrane and seat seal are replaced.
- 3 The valve is reassembled and the valve cover bolts are tightened to a defined torque..
- 4 The free movement of the valve spindle is checked.
- 5 Every five years, the pilot valve is opened and both the membrane and seat seal are replaced.
- 6 We then commission the valve again and regulate it precisely, conduct a comprehensive functional inspection and check the set pressures.

Application example of regulating valves



1 Application technology for complex assemblies

The experienced application engineers from Hawle provide you with support in the design of complex hydraulic projects. We have the most advanced tools for this.

2 Regulating valves in a row and controlled remotely

Valves can be installed in a row in order to reduce the pressure over large areas. In addition to this, we offer various possibilities to control the valves remotely from a control centre. This means they can be optimally integrated into existing systems.

3 Accessories and special solutions

Not every job can be solved with a standard product. Thanks to our extensive know-how and years of experience, we can find a solution that is optimally adapted to your needs. We can also draw on a variety of accessories.

Regulating valves – Valve assembly

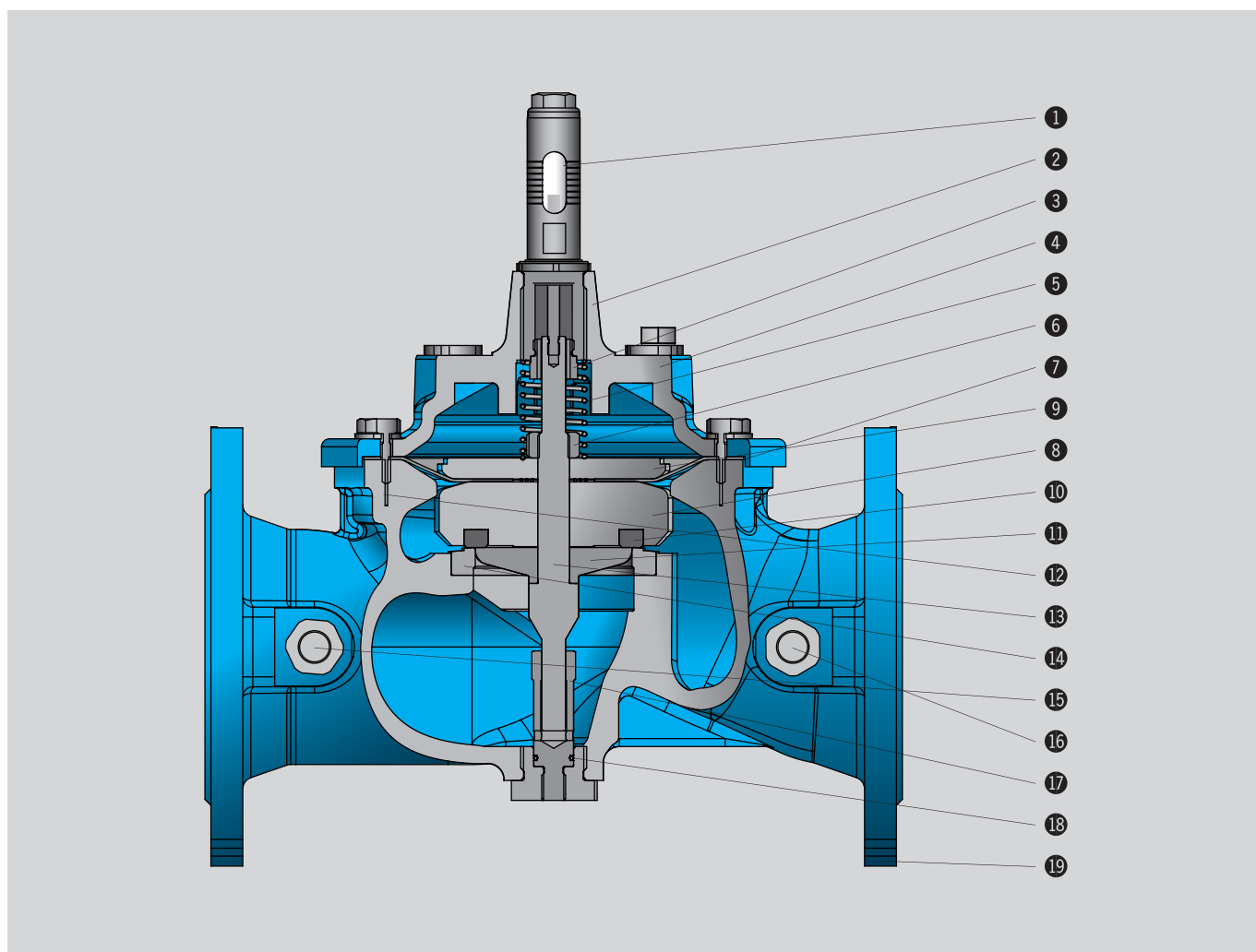

Components

- 1 Optical position indicator
- 2 Cover
- 3 Spindle guide, cover
- 4 Control line connection, cover
- 5 Spring
- 6 Nut
- 7 Diaphragm
- 8 Seal support
- 9 Pressure disc
- 10 Seat of the seal
- 11 Counter seat
- 12 Hexagonal screw
- 13 Spindle
- 14 Seat
- 15 Control line connection, housing (inlet)
- 16 Control line connection, housing (outlet)
- 17 Spindle guide, housing
- 18 O-ring
- 19 Housing

Regulating valves – dimensional tables for straight valves

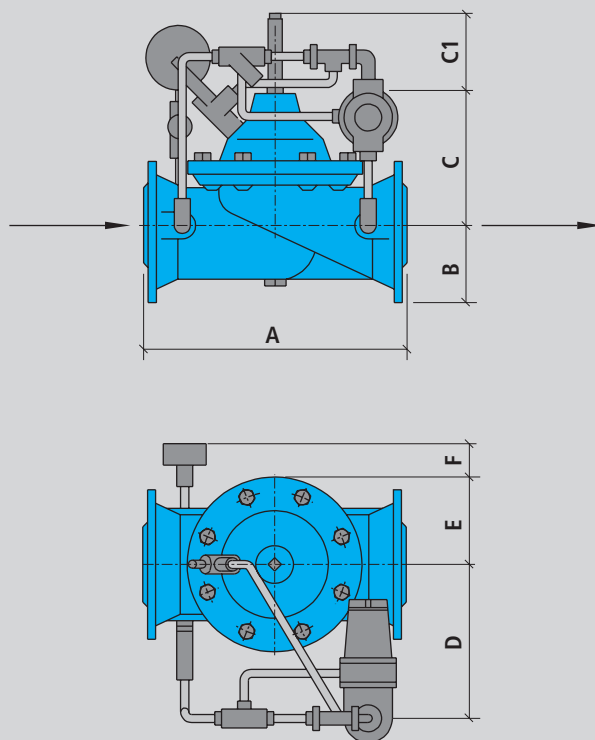

Construction lengths acc. to DIN EN 558

Flange connection size according to DIN EN 1092-2

Pressure gauge EN 837-1; Accuracy class 1.6

	PN [bar]	¹⁾ 1 1/2" – 2" [mm]	DN 40 [mm]	DN 50 [mm]	DN 65 [mm]	DN 80 [mm]	DN 100 [mm]	DN 125 [mm]	DN 150 [mm]	DN 200 [mm]	DN 250 [mm]	DN300 [mm]
A	10/16/25	210	200	230	290	310	350	400	480	600	730	850
B	10/16	40	75	80	90	100	110	125	140	170	200	235
	25	40	75	80	90	100	115	135	150	180	–	–
C		130	130	130	150	160	195	245	278	330	405	365
D		160	160	160	170	180	190	205	220	250	275	740
E		65	70	70	85	105	115	145	160	200	250	740
F ²⁾		–	80	80	65	65	65	45	40	20	–	–
Valve with optical position indicator												
C1		85	85	85	85	85	85	112	112	112	112	135
Valve with electrical position indicator												
C1		138	138	138	138	138	138	164	164	164	180	180

¹⁾ with threaded outlet

²⁾ guideline value depending on valve type

Regulating valves – dimensional tables corner valve

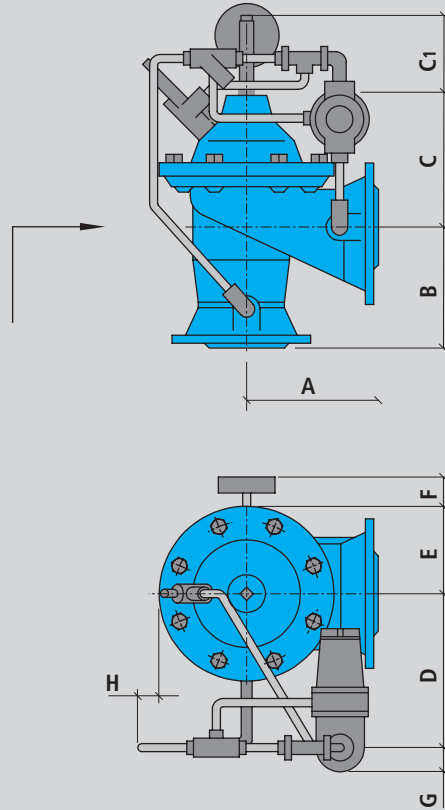

Construction lengths acc. to DIN EN 558

Flange connection size according to DIN EN 1092-2

Pressure gauge EN 837-1; Accuracy class 1.6

	DN 50 [mm]	DN 80 [mm]	DN 100 [mm]	DN 150 [mm]
A	125	155	190	250
B	125	155	175	225
C	145	195	225	320
D	170	160	220	250
E	85	115	145	200
F	55	70	55	55
G	40	40	40	40
H	30	–	–	–
Valve with optical position indicator				
C1	80	80	80	135
Valve with electrical position indicator				
C1	138	138	138	180

Regulating valves Pressure loss diagramm and K_{VS} -values

Loss of pressure Δp subject to flow Q and nominal width DN Flow
power factor K_{VS} in m^3/h and l/min where $\Delta p = 1$ bar

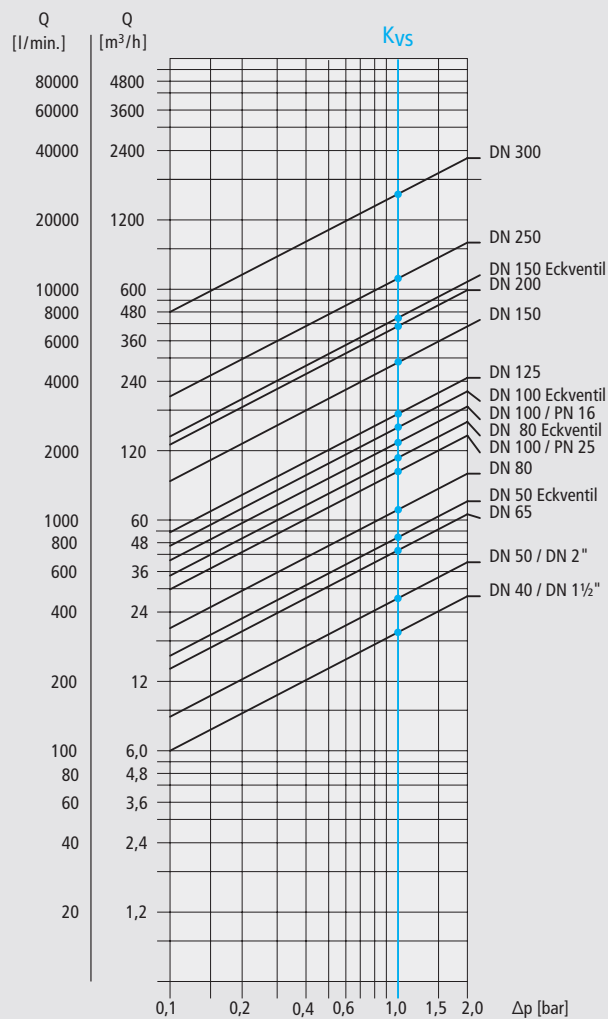

DN	K_{VS} straight valve		DN	K_{VS} corner valve	
	m^3/h	l/min.		m^3/h	l/min.
40	19	315	40	—	—
50	27	460	50	51	850
65	43	725	65	—	—
80	68	1140	80	111	1850
100/PN 16	129	2150	100	156	2600
100/PN 25	106	1770	125	—	—
125	177	2955	150	432	7200
150	297	4960	200	—	—
200	415	6925	250	—	—
250	681	11360	300	—	—
300	1476	24600			

Regulating valves performance diagram for straight valves

The ideal working range for Hawido valves is between $H = 15\%$ and 80% (coloured area). If the set value is below the minimum or above the maximum, get personal advice.

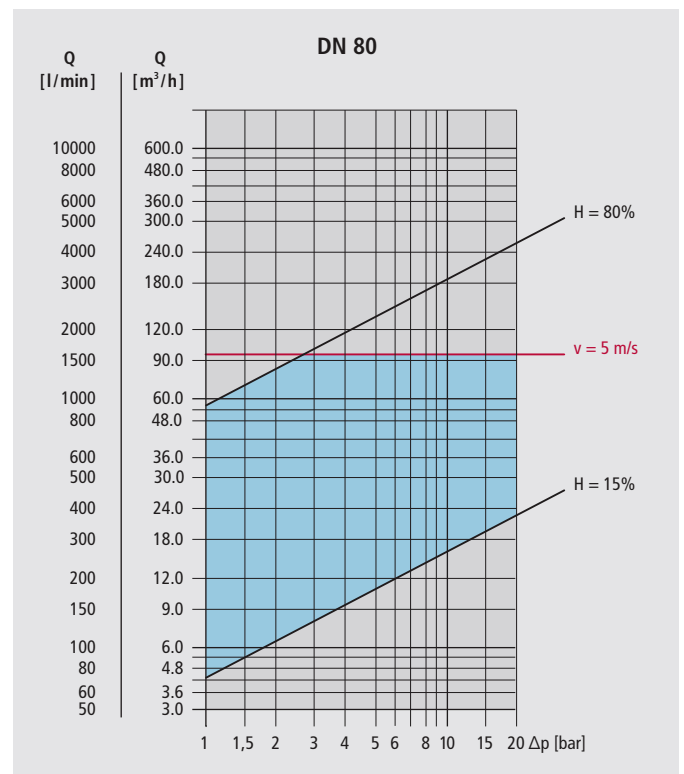
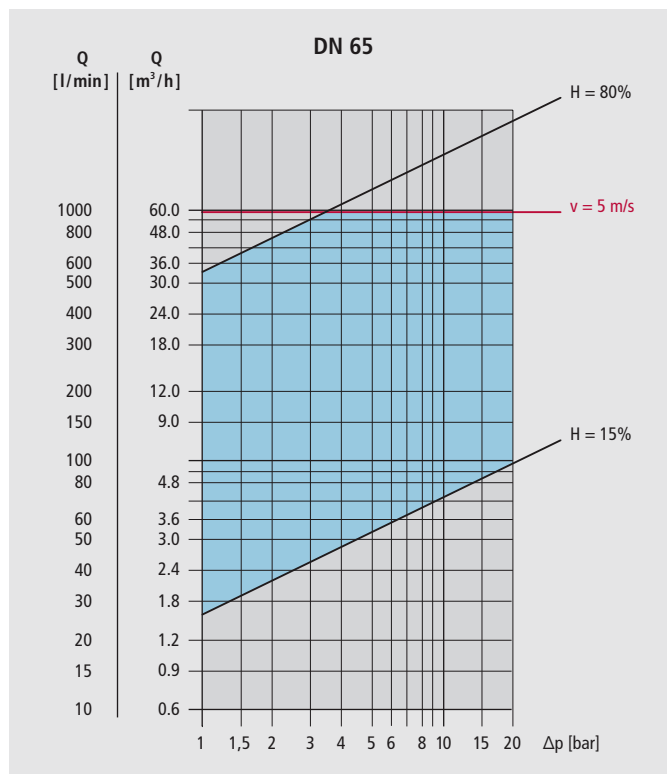
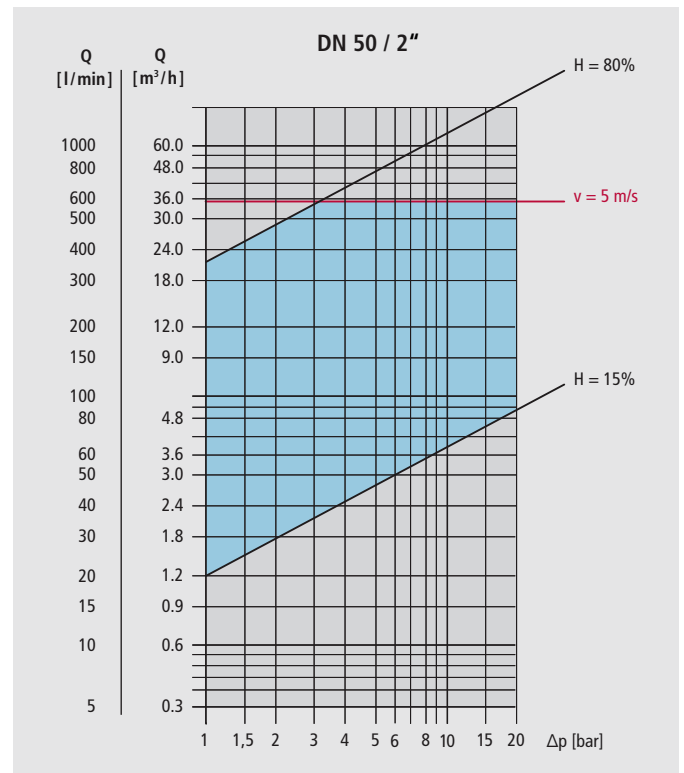
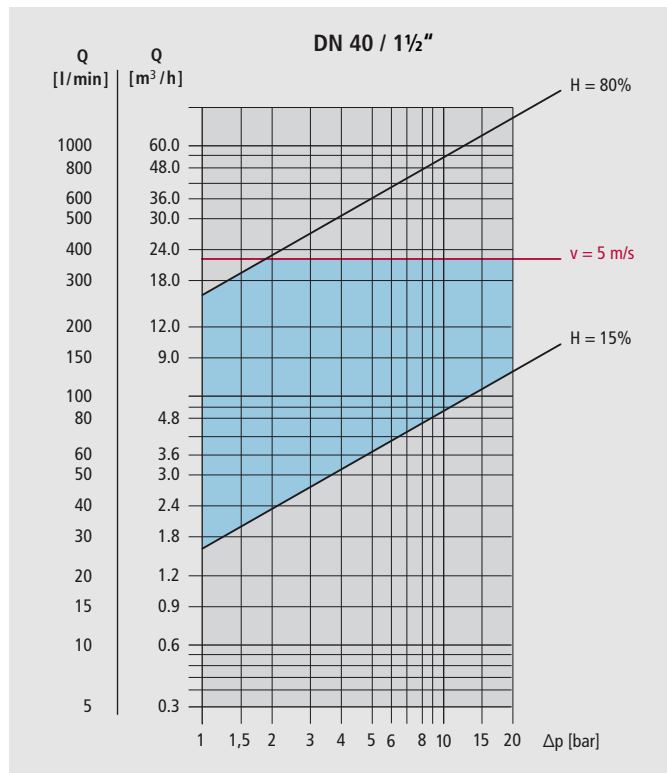

Regulating valves performance diagram for straight valves

The ideal working range for Hawido valves is between $H = 15\%$ and 80% (coloured area). If the set value is below the minimum or above the maximum, get personal advice.

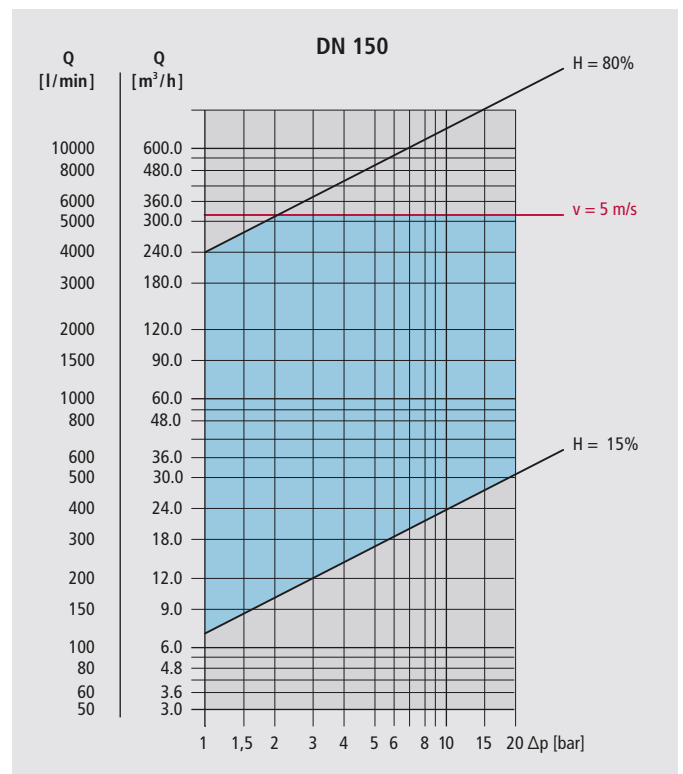
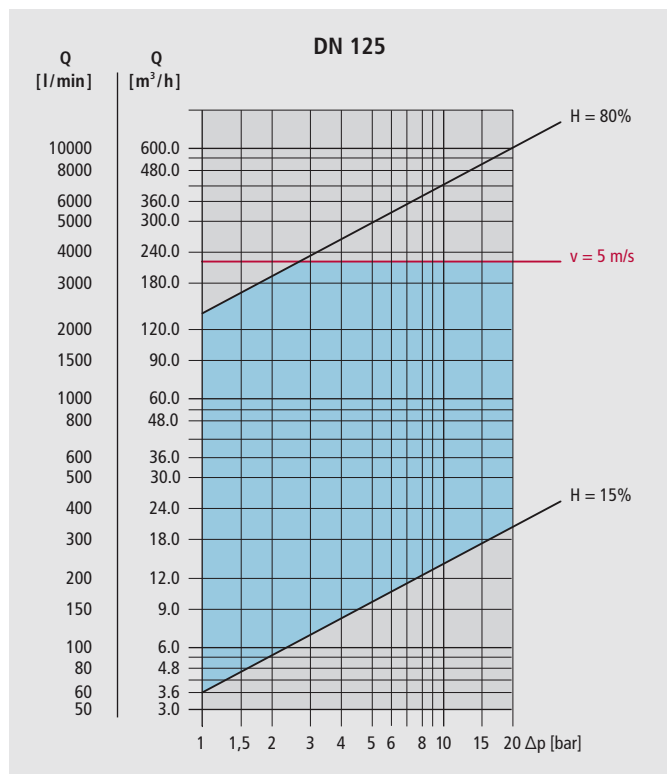
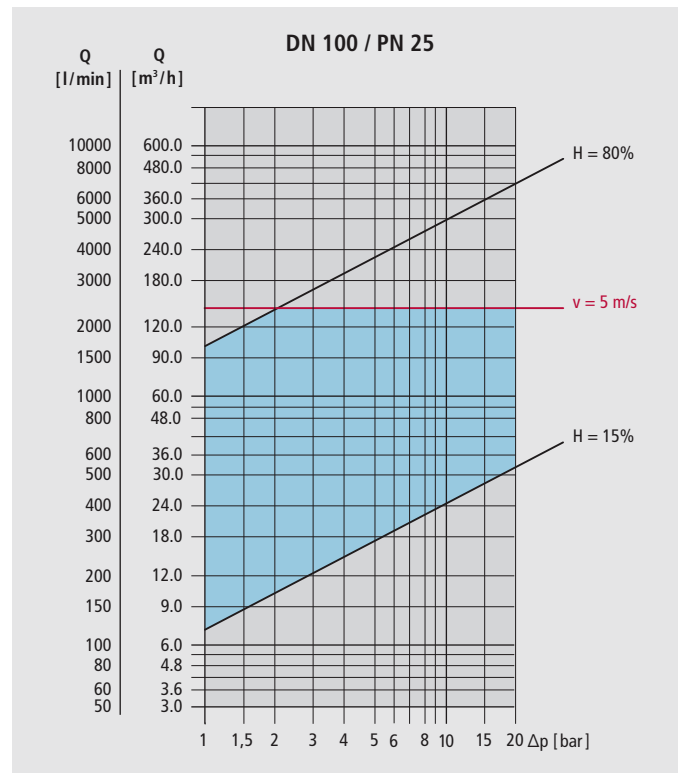
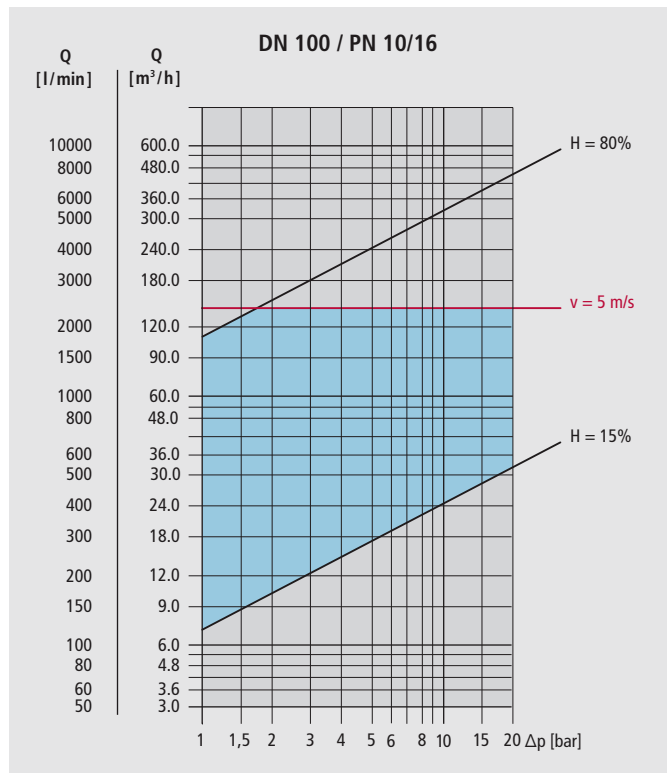

Regulating valves performance diagram for straight valves

The ideal working range for Hawido valves is between $H = 15\%$ and 80% (coloured area). If the set value is below the minimum or above the maximum, get personal advice.

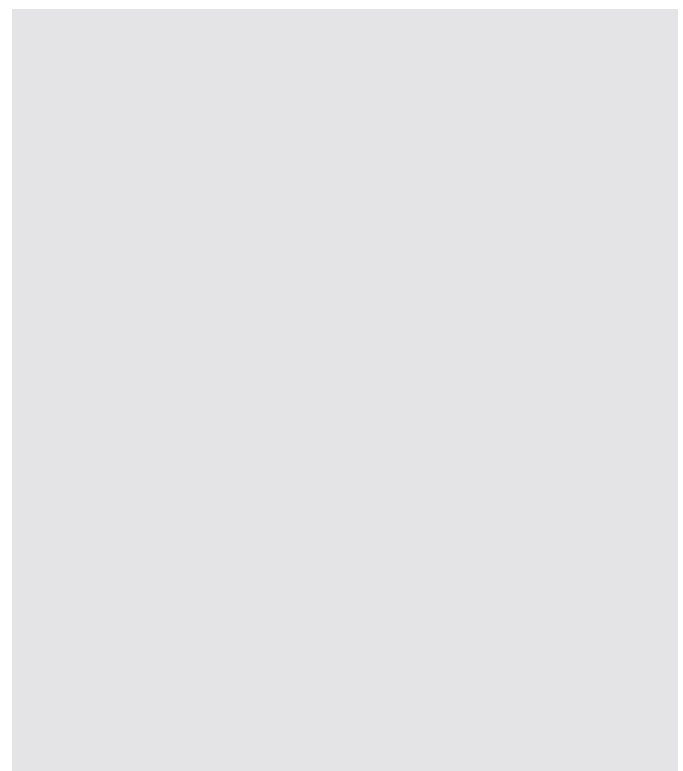
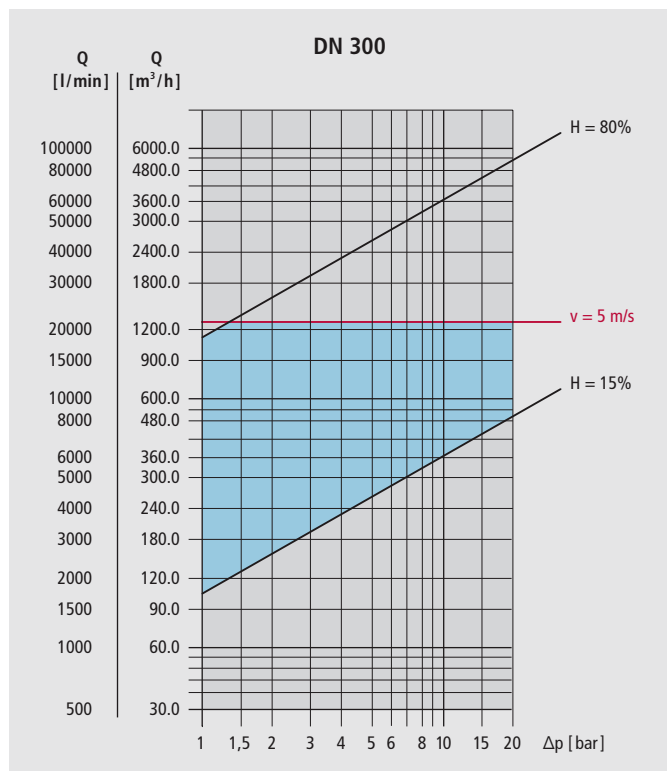
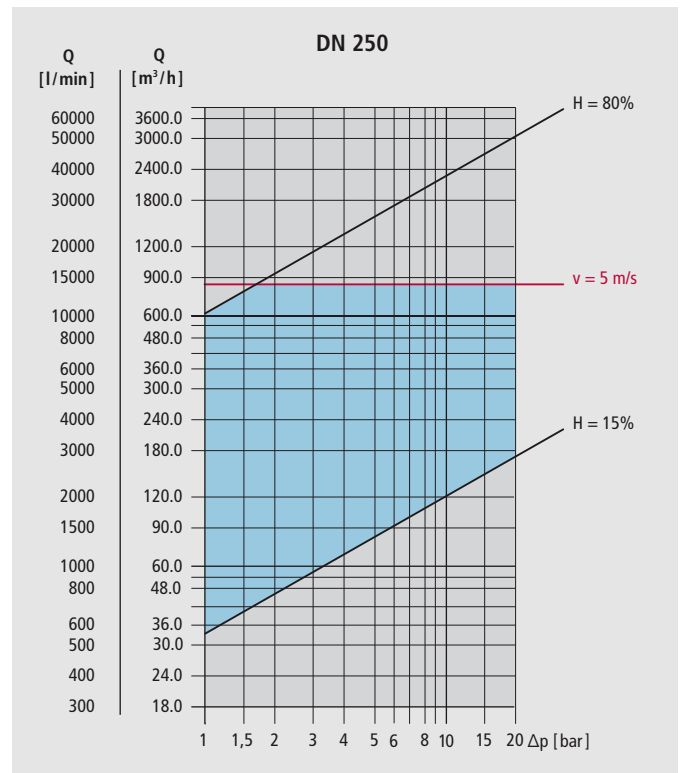
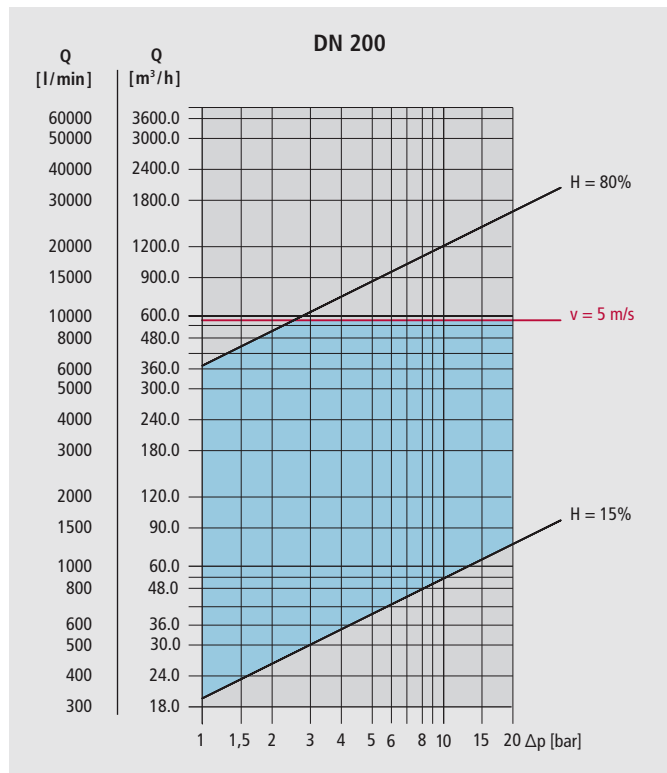

Regulating valves performance diagram for straight valves

The ideal working range for Hawido valves is between $H = 15\%$ and 80% (coloured area). If the set value is below the minimum or above the maximum, get personal advice.

